



# MR-1

Rating: 6A 125V AC

4.5A 250V AC

Contact Resistance: 50mΩ Max

Insulation Resistance: DC 500V 100MΩ Min

Dielectric Strength: AC1500V 1 minute

Electrical life: 10,000 cycles

Operating Temperature: 0°C~85°C

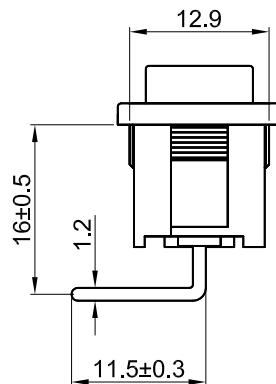
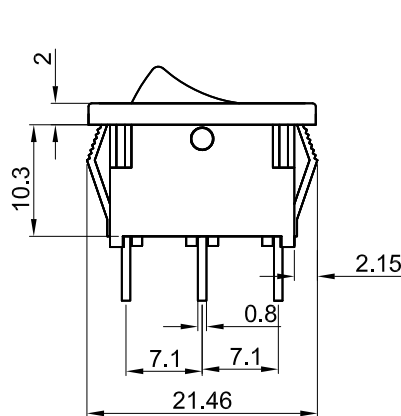
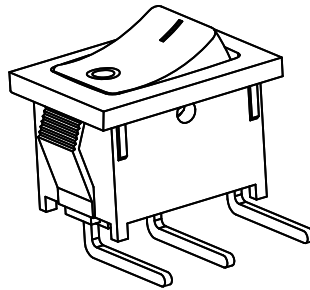
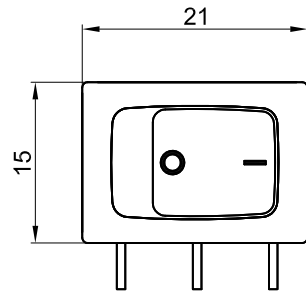

CUT-OUT

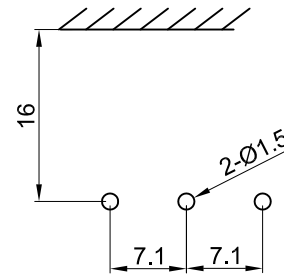

CUT-OUT

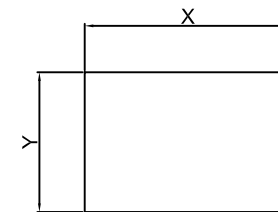

	X	Y
0.75~1.25	19.2-0.1	13.0+0.1
1.25~2.00	19.4-0.1	13.0+0.1
2.00~3.00	19.8-0.1	13.0+0.1

SWITCHING CIRCUIT

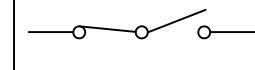

## MATERIAL:

Body:Nylon66,UL rated:94V-2 min

Actuator:Nylon66,UL rated:94V-2 min

Terminal:Brass,silver or tin plated

0	1	2	3	4	5	7	8	9	A	B	C	D	E	G	H	J	L
None		ON OFF				ON/开 OFF/关									开关		

				公差 TOLERANCES		.X±0.3		.XX±0.15		角度 ANGLE ± 1°		单位 DIMENSION UNIT mm.					
				版本 VERSION	A1	比例尺 SCALE	NONE	日期 DATE	2020.07.17	品名 TITLE		MR-1-124-C5N-BB		图号 DRAWING NO			
				核准		核对	Z.H.B.	绘图						MR-1-124-C5N-BB_A1			
版本 VER.	变更说明 CHANGE DESCRIPTION			日期 DATE	ECN NO.	APPROVED BY	CHECKED BY	DRAWN BY									